



---

# PARTS CATALOG

" a cut above in Service and Dependability "

Help us customize our catalog  
to your needs

Tel: 954-428-9797      Fax: 954-428-9191

[WWW.OPERATION32.COM](http://WWW.OPERATION32.COM)

---

5051 N.W 13th Ave, Suite C, Deerfield Beach, FL 33064



www.operation32.com

# PARTS CATALOG

Tel: 954-428-9797

Fax: 954-428-9191

## Introduction

Founded in 2007, Operation 32 has become the main source in South Florida, solely dedicated, to all your cut-to-size needs.

At Operation 32 we are a business to business CNC manufacturer of closet components, cabinet parts and other built to order custom panel processing goods.

Our facility is committed solely to your production and we strive to continually improve our relationships with our clients and suppliers to offer the very best service out there! State-of-the art CNC machinery using the 32mm system allows us to be an excellent value to you as a custom manufacturer of all your panel goods.

We are the ideal solution for all cabinet and closet organizations that want to increase profits by decreasing overhead and outsourcing manufacturing needs.

You will love our fast service and high-volume of competitive pricing! We are conveniently located on the border of Palm Beach and Broward Counties, in Deerfield Beach Florida.

## Why "Operation 32"?

With state of the art CNC machinery to serve you both promptly and accurately, Operation 32 is able to keep costs down which are passed on to you the customer!

We encourage you to spend more time on sales! Once your job has been confirmed by your client, using "Operation 32", will allow you to continue with what you specialize in, sell, sell, sell!

With excellent customer support representatives, we are always here to help you in the ordering process.

At "Operation 32", we ensure no surprises for our clients other than exceeding your expectations.

\*\*\*\*We can accommodate any size order. No job is too large or too small.

\*\*\*\*Please call for pricing and details.

## Component Features

- Precision manufacturing of many custom components including closet, cabinet, and furniture parts!.
- Panels and components using any thickness material, exactly to your specifications!
- A wide variety of stock melamine colors that combine a quality finish with a reasonable price. Giving you numerous options in a host of applications!
- Parts are machined for shelving, connecting or hanging. Everything is built to order!
- Edge bandging capabilities of 0.5mm, 2mm, 3mm, veneer !

5051 N.W 13th Ave, Suite C, Deerfield Beach, FL 33064



www.operation32.com

# PARTS CATALOG

## INTRODUCTION

Tel: 954-428-9797

Fax: 954-428-9191

### CHECK OUT OUR CATALOG!

Operation 32 has created a Parts Catalog for your ordering convenience. It is our goal to make ordering parts simple and easy. Please reference our catalog and request parts by our part name to ensure order accuracy.

### CANNOT FIND YOUR PART?

In this case, please see our attached sheet labeled "Create Parts." We will be happy to add any custom part that you would like to be repeatable and precise. In the future, this part will be available by Part Name when ordering. Please be aware that there are additional charges for drafting custom parts. This charge is typically \$20.00. However, depending on complexity and size this price may vary.

### EDGE BANDING IS INCLUDED!

Our parts include .04mm matching edge tape running the length of the part. We have noted this with an "E" on our drawing. If you request additional edge banding, please check the appropriate box on the Order Form. If the part is exactly the way you want it, no box will have to be checked. We will always include one length of edge banding. If additional edge banding is requested they will incur charges. Typically, \$1.95 per length.

5051 N.W 13th Ave, Suite C, Deerfield Beach, FL 33064



www.operation32.com

# PARTS CATALOG

Quick Reference

Tel: 954-428-9797

Fax: 954-428-9191

## REVERSIBLE PANELS

When ordering drilled vertical, please reference our "Panel sizing table".  
When ordering from the 32mm Panel Sizing Table there are no left and right.  
The drilling pattern starts 10mm from the top and ends 10mm from the bottom.  
If the panel has a notch, left and right must be indicated.

## PLEASE USE MILLIMETERS

SHORTCUT DEPTH                      Shelves: B0, FS, AS

REFERENCE:

12" = 305mm

14" = 355mm

16" = 406mm

18" = 457mm

24" = 610mm

SHORTCUT LENGTH                      Panels: B1, B2, BSP

REFERENCE:

84" = 2132mm

96" = 2420mm

108" = 2740mm

Various lengths multiply (x) inches by 25.4

Feel free to contact us with any questions or comments.

It will be our pleasure to explain the 32mm system.

5051 N.W 13th Ave, Suite C, Deerfield Beach, FL 33064

## BASE NOTCH FOR YOUR PANELS

Base Notches are available for an upcharge per panel it is important to note left's and right's correctly. list all base notch sizes on the details column of the order form. It could look like this : B=BDxBH. Example: B=20X152. To help you determine which panels are left or right Review the example plan view below.

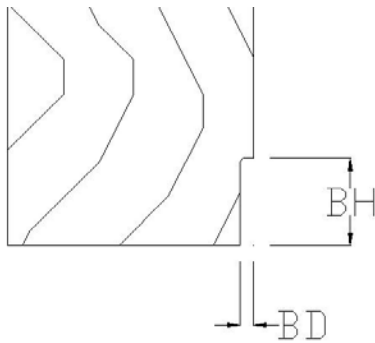

### TOE KICK HEIGHT RECOMMENDED UNDER THE 32mm SYSTEM

- 64mm HEIGHT
- 96mm HEIGHT
- 128mm HEIGHT

INCREMENTS OF 32mm

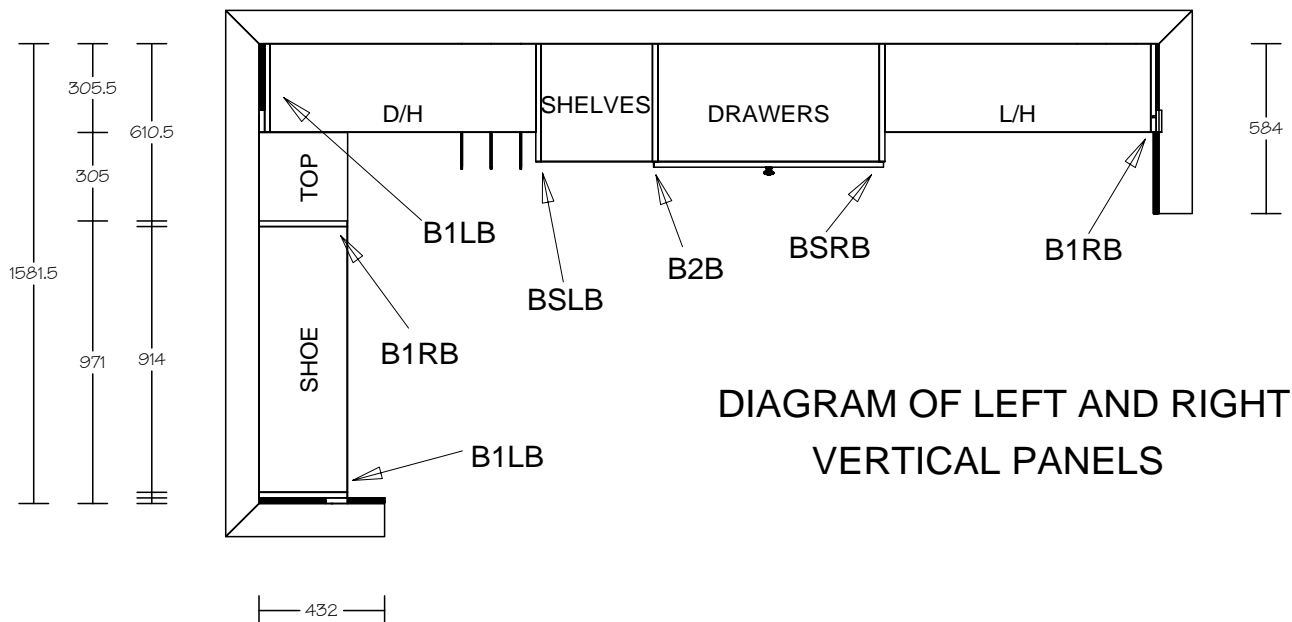
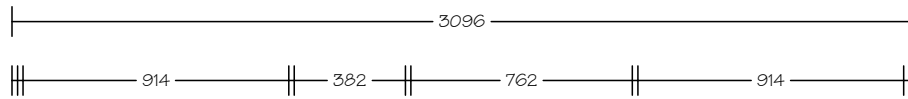
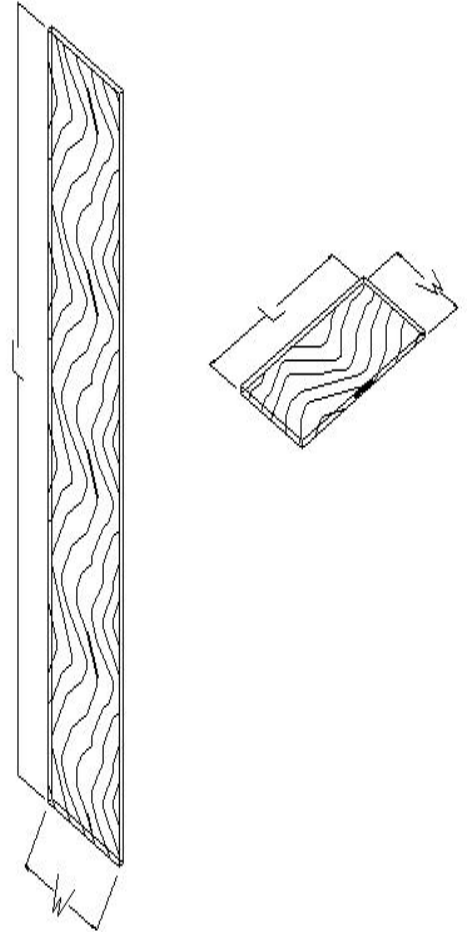

DIAGRAM OF LEFT AND RIGHT VERTICAL PANELS

Please note it is EXTREMELY important to have your WIDTHS and LENGTHS in the right order. This is very critical when using wood grain's. This is a common mistake and is the customer's responsibility to make sure that everything is in the right order



Drawer Fronts have the option to be either Horizontal or Vertical grain  
The order in which you write the dimensions will determine this.  
below you will see an example

HORIZONTAL

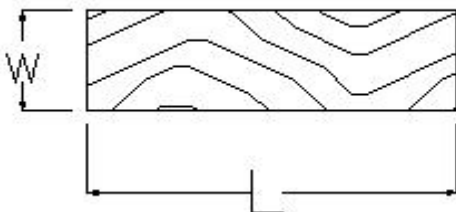

VERTICAL

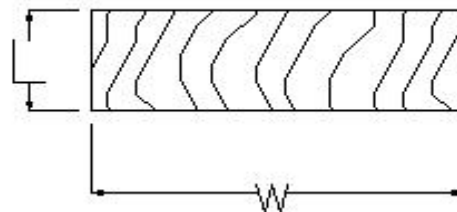

RULE TO REMEMBER

GRAIN ALWAYS GOES WITH THE LENGTH

DRAWER AND DOORS FOLLOW THE 32mm SYSTEM

DOORS AND DRAWER FRONTS SHOULD FOLLOW THE 32mm SYSTEM IN INCREMENTS OF 32mm ON THE HEIGHT AND WITH THE 3mm (1/8") REVEALS

RECOMMENDED HEIGHT

125mm ( 4.92" )

157mm ( 6.18" )

189mm ( 7.44" )

221mm ( 8.70" )

253mm ( 9.96" )

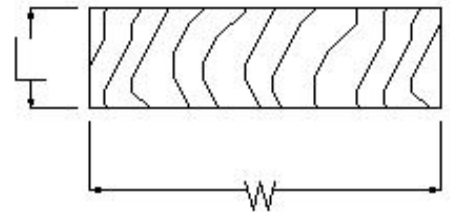

HINGE DRILL

FOR 35mm DRILL  
OPERATION32 CAN DRILL YOUR HINGES HOLE  
FOR 3mm (1/8") REVEALS

DOOR4 (FOR 4 HINGES)

DRILL 87mm  
FROM TOP AND BOTTOM  
AND 2 EQUAL FROM CENTER

DOOR3 (FOR 3 HINGES)

DRILL 87mm  
FROM TOP AND BOTTOM  
AND CENTER

DOOR2 (FOR 2 HINGES)

DRILL 87mm  
FROM TOP AND BOTTOM

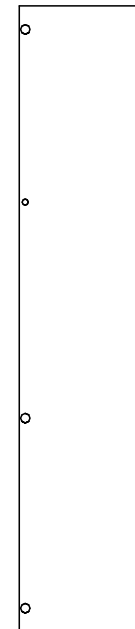
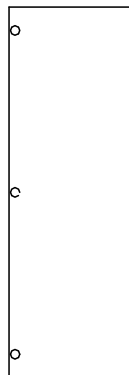
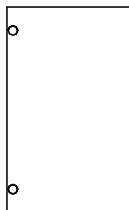

CUSTOMER TO GIVE SCHEMATIC IF DRILLING PATTERN DIFFERENT



# PARTS CATALOG

Tel: 954-428-9797

www.operation32.com

Quick Reference

Fax: 954-428-9191

## CUSTOM CORNER SHELF

OPERATION 32 CAN ROUTE YOU CUSTOM CORNER SHELF  
EACH SHELF REQUIRE SCHEMATIC.  
WE REQUIRE TOP VIEW OF THE SHELF

### ORDER NAME

CRFS - CORNER FIXED SHELF

CRAS - CORNER ADJUSTABLE SHELF(WITH ROUTH FOR PIN)

CRBO - CORNER BLANK SHELF

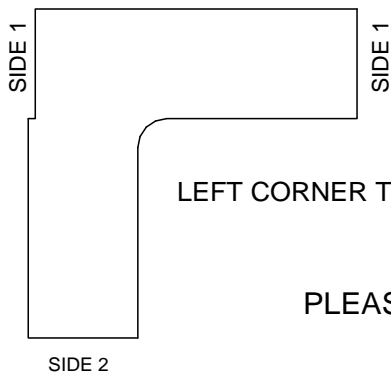

LEFT CORNER TYPE A

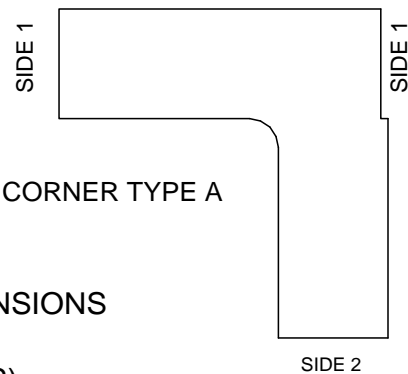

RIGHT CORNER TYPE A

PLEASE PROVIDE ALL DIMENSIONS

FULL LENGTH (GRAINS)  
FULL DEPTH

AND ALL SIZE OF ATTACHED VERTICAL TO THE CORNER SHELF

SIDE1

SIDE 2

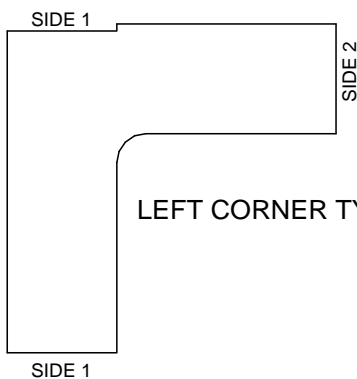

LEFT CORNER TYPE B

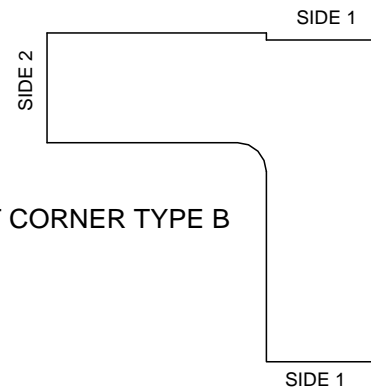

RIGHT CORNER TYPE B

PLEASE SEND US DRAWING WITH ALL REQUIRED DIMENSIONS

5051 N.W 13th Ave, Suite C, Deerfield Beach, FL 33064



www.operation32.com

# PARTS CATALOG

## Panel Sizing Table

Tel: 954-428-9797

Fax: 954-428-9191

Whole Inches	32mm length Plus 20mm	32mm Spaces	Decimal Length	Whole Inches	32mm length Plus 20mm	32mm Spaces	Decimal Length
11	276	8	10.87	65	1652	51	56.04
12	308	9	12.13	66	1684	52	66.3
13/14	340	10	13.39	67/68	1716	53	67.56
15	372	11	14.65	69	1748	54	68.81
16	404	12	15.91	70	1780	55	70.08
17	436	13	17.17	71	1812	56	71.3
18/19	468	14	18.43	72/73	1844	57	72.56
20	500	15	19.68	74	1876	58	73.82
21	532	16	20.94	75	1908	59	75.08
22	564	17	22.2	76	1940	60	76.34
23/24	596	18	23.46	77/78	1972	61	77.6
25	628	19	24.72	79	2004	62	78.86
26	660	20	25.98	80	2036	63	80.12
27	692	21	27.24	81/82	2068	64	81.38
28/29	724	22	28.5	83	2100	65	82.64
30	756	23	29.76	84	2132	66	83.9
31	788	24	31.02	85	2164	67	85.16
32	820	25	32.28	86/87	2196	68	86.42
33/34	852	26	33.54	88	2228	69	87.68
35	884	27	34.8	89	2260	70	88.94
36	916	28	36.06	90	2292	71	90.2
37	948	29	37.32	91/92	2324	72	91.46
38/39	980	30	38.58	93	2356	73	92.72
40	1012	31	39.84	94	2388	74	93.97
41	1044	32	41.1	95	2420	75	95.23
42	1076	33	42.36	96	2452	76	96.48
43/44	1108	34	43.62	97/98	2484	77	97.74
45	1140	35	44.88	99	2516	78	99.0
46	1172	36	46.14	100	2548	79	100.26
47/48	1204	37	47.4	101/102	2580	80	101.52
49	1236	38	48.66	103	2612	81	102.78
50	1268	39	49.92	104	2644	82	104.04
51	1300	40	51.18	105	2676	83	105.3
52/53	1332	41	52.44	106/107	2708	84	106.56
54	1364	42	53.7	108	2740	85	107.82
55	1396	42	54.96	109	2772	86	109.08
56	1428	44	56.22	110	2804	87	110.34
57/58	1460	45	57.48	112	2836	88	111.6
59	1492	46	58.74	113	2868	89	112.86
60	1524	47	60	114	2900	90	114.12
61	1556	48	61.26	115/116	2932	91	115.38
62/63	1588	49	62.52	117	2964	92	116.64
64	1620	50	63.78	118	2996	93	117.9

5051 N.W 13th Ave, Suite C, Deerfield Beach, FL 33064



www.operation32.com

# PARTS CATALOG

## CLOSET VERTICAL PANELS

Tel: 954-428-9797

Fax: 954-428-9191



**B0**  
BLANK VERTICAL PANEL  
L = HEIGHT  
W = DEPTH  
EDGE IN FRONT UNIT

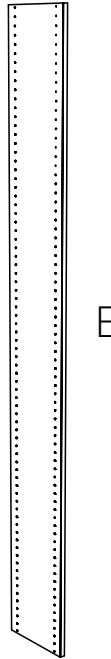

**B1**  
CLOSET VERTICAL PANEL  
STOP DRILLED  
DRILLED 37mm FRONT AND BACK  
L = HEIGHT  
W = DEPTH  
EDGE IN FRONT OF UNIT

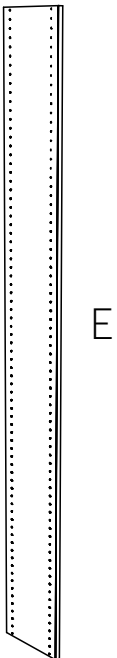

**B2**  
CLOSET VERTICAL PANEL  
THRU DRILLED  
DRILLED 37mm FRONT AND BACK  
L = HEIGHT  
W = DEPTH  
EDGE IN FRONT OF UNIT

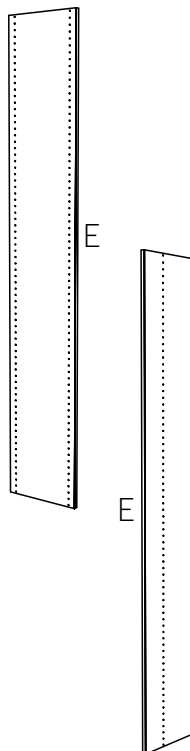

**BSP**  
SPECIAL DRILLED VERTICAL PANEL  
STANDARD SPECIAL IS DRILLED FOR  
16" ONE SIDE AND 12" ON THE OTHER  
L = HEIGHT  
W = DEPTH  
EDGE IN FRONT OF UNIT  
  
CUSTOMER TO GIVE SCHEMATIC IF  
DRILLING PATTERN IS DIFFERENT



**B0B**

BLANK VERTICAL PANEL  
NOTCH FOR BASE BOARD

L = HEIGHT

W = DEPTH

B = BD X BH

EDGE IN FRONT UNIT

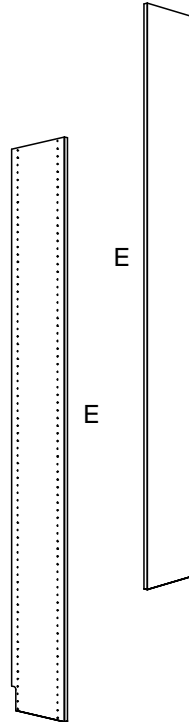
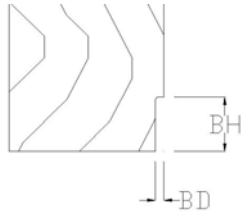

**B1LB / B1RB**

CLOSET VERTICAL PANEL  
STOP DRILLED  
DRILLED 37mm FRONT AND BACK  
NOTCH FOR BASE BOARD

L = HEIGHT

W = DEPTH

B = BD X BH

EDGE IN FRONT OF UNIT

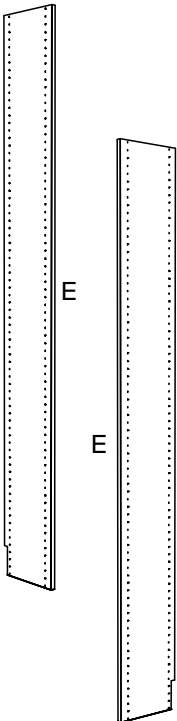

**B2B**

CLOSET VERTICAL PANEL  
THRU DRILLED  
DRILLED 37mm FRONT AND BACK  
NOTCH FOR BASE BOARD

L = HEIGHT

W = DEPTH

B = BD X BH

EDGE IN FRONT OF UNIT

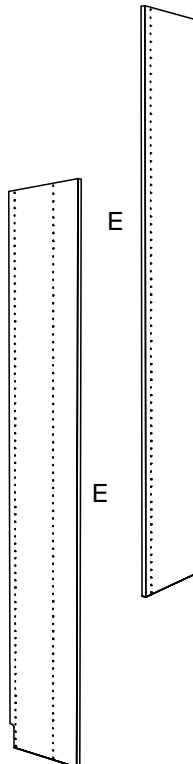

**BSLB / BSRB**

SPECIAL DRILLED VERTICAL PANEL  
STANDARD SPECIAL IS DRILLED FOR  
16" ONE SIDE AND 12" ON THE OTHER  
NOTCH FOR BASE BOARD

L = HEIGHT

W = DEPTH

B = BD X BH

EDGE IN FRONT OF UNIT

CUSTOMER TO GIVE SCHEMATIC IF  
DRILLING PATTERN IS DIFFERENT

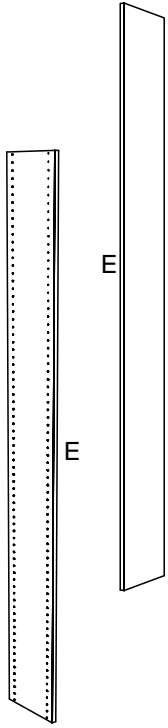

**B1LF / B1RF**

STOP DRILLED VERTICAL PANEL  
 DRILLED 37mm FRONT AND BACK  
 DRILLED FOR FEET

L = HEIGHT

W = DEPTH

EDGE IN FRONT UNIT

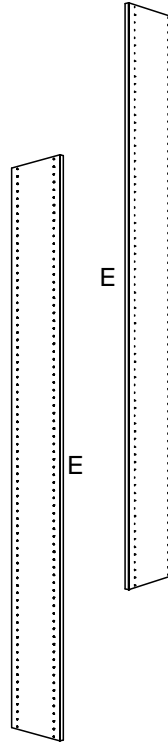

**B2F**

THRU DRILLED VERTICAL PANEL  
 DRILLED 37mm FRONT AND BACK  
 DRILLED FOR FEET

L = HEIGHT

W = DEPTH

EDGE IN FRONT OF UNIT

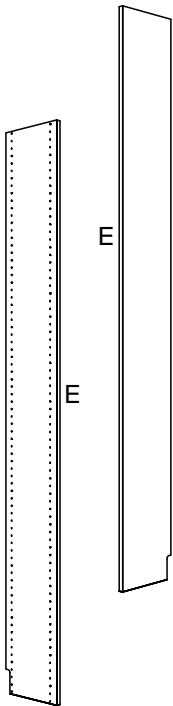

**B1LBF / B1RBF**

STOP DRILLED VERTICAL PANEL  
 DRILLED 37mm FRONT AND BACK  
 NOTCH FOR BASE BOARD  
 DRILLED FOR FEET

L = HEIGHT

W = DEPTH

B = BD X BH

EDGE IN FRONT OF UNIT

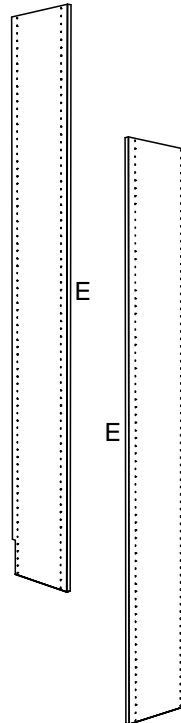
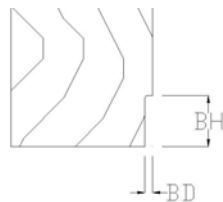

**B2BF**

THRU DRILLED VERTICAL PANEL  
 DRILLED 37mm FRONT AND BACK  
 NOTCH FOR BASE BOARD  
 DRILLED FOR FEET

L = HEIGHT

W = DEPTH

B = BD X BH

EDGE IN FRONT OF UNIT

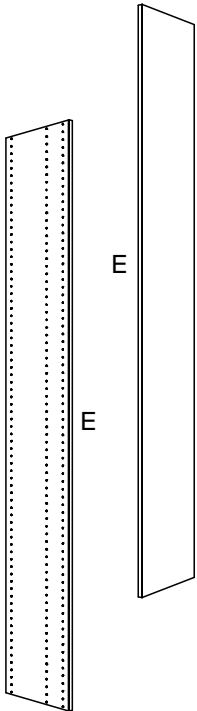

**3LB1**

STOP DRILLED VERTICAL PANEL  
 3 LINE BORES  
 DRILLED 37mm FRONT AND BACK  
 CENTER BORE TO 12" VERTICAL

L = HEIGHT  
 W = DEPTH

EDGE IN FRONT UNIT

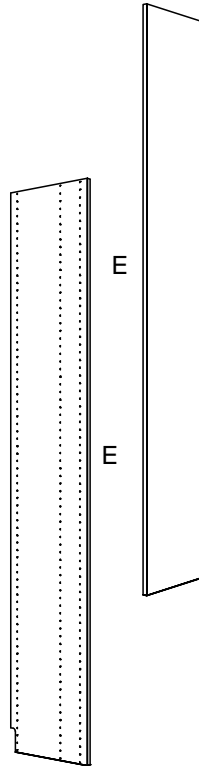

**3LB1LB / 3LB1RB**

STOP DRILLED VERTICAL PANEL  
 3 LINE BORES  
 DRILLED 37mm FRONT AND BACK  
 CENTER BORE TO 12" VERTICAL  
 NOTCH FOR BASE BOARD

L = HEIGHT  
 W = DEPTH  
 B = BDxBH

EDGE IN FRONT OF UNIT

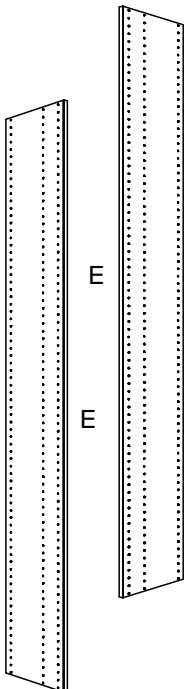
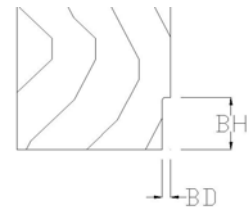

**3LB2**

THRU DRILLED VERTICAL PANEL  
 3 LINE BORES  
 DRILLED 37mm FRONT AND BACK  
 CENTER BORE TO 12" VERTICAL

L = HEIGHT  
 W = DEPTH

EDGE IN FRONT OF UNIT

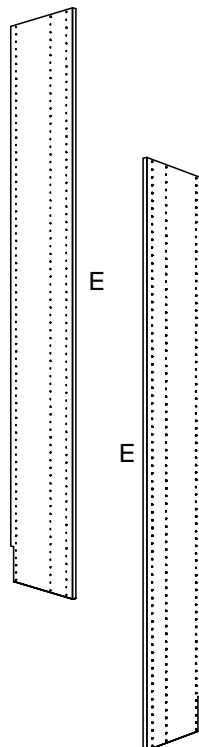

**3LB2B**

THRU DRILLED VERTICAL PANEL  
 3 LINE BORES  
 DRILLED 37mm FRONT AND BACK  
 CENTER BORE TO 12" VERTICAL  
 NOTCH FOR BASE BOARD

L = HEIGHT  
 W = DEPTH  
 B = BDxBH

EDGE IN FRONT OF UNIT

CUSTOMER TO GIVE SCHEMATIC IF  
 DRILLING PATTREN IS DIFFERENT



www.operation32.com

# PARTS CATALOG

## CLOSET VERTICAL PANELS

Tel: 954-428-9797

Fax: 954-428-9191

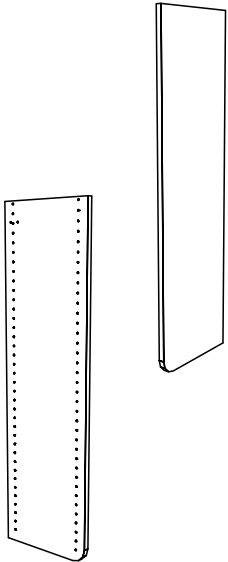

### WRB1L / WRB1R

STOP DRILLED WALL HANGING  
DRILLED 37mm FRONT AND BACK  
WITH RADIUS BOTTOM  
DRILL FOR HANGING BRACKET  
CONTOUR EDGE BAND REQUIRED

L = HEIGHT  
W = DEPTH

EDGE IN FRONT UNIT

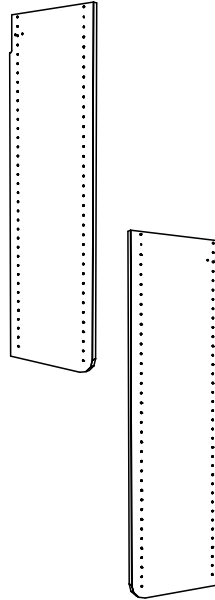

### WRB2

THRU DRILLED WALL HANGING  
DRILLED 37mm FRONT AND BACK  
WITH RADIUS BOTTOM  
NOTCH AND DRILL FOR  
HANGING BRACKET  
CONTOUR EDGE BAND REQUIRED

L = HEIGHT  
W = DEPTH

EDGE IN FRONT OF UNIT

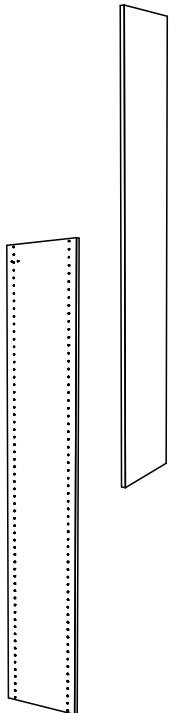

### WSB1L / WSB1R

STOP DRILLED WALL HANGING  
DRILLED 37mm FRONT AND BACK  
SQUARE BOTTOM  
DRILL FOR HANGING BRACKET

L = HEIGHT  
W = DEPTH

EDGE IN FRONT OF UNIT

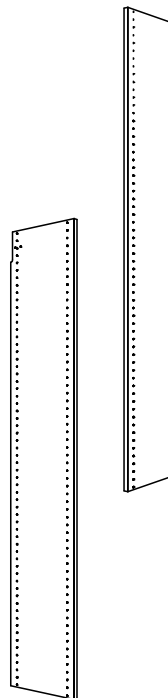

### WSB2

THRU DRILLED WALL HANGING  
DRILLED 37mm FRONT AND BACK  
SQUARE BOTTOM  
NOTCH AND DRILL FOR  
HANGING BRACKET

L = HEIGHT  
W = DEPTH

EDGE IN FRONT OF UNIT

## PARTS CATALOG

### CLOSET VERTICAL PANELS

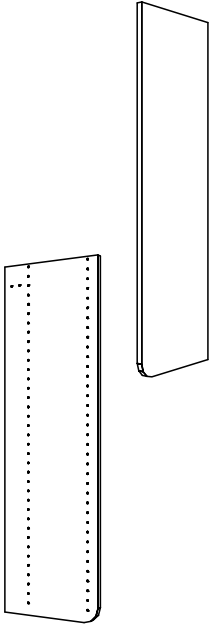

#### W14RB1L / W14RB1R

STOP DRILLED WALL HANGING  
DESIGNS FOR 14" DEPTH VERTICAL  
DRILLED 37mm FROM FRONT  
261 FROM FRONT  
WITH RADIUS BOTTOM  
DRILL FOR HANGING BRACKET  
CONTOUR EDGEBAND REQUIRED

L = HEIGHT

W = DEPTH

EDGE IN FRONT UNIT

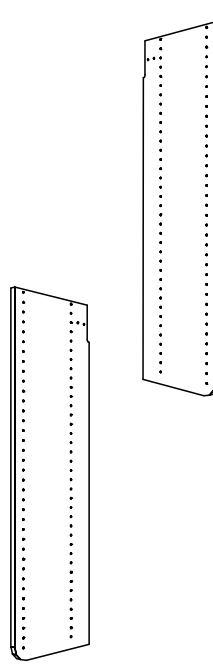

#### W14RB2

THRU DRILLED WALL HANGING  
DESIGNS FOR 14" DEPTH VERTICAL  
DRILLED 37mm FROM FRONT  
261mm FROM FRONT  
WITH RADIUS BOTTOM  
NOTCH AND DRILL FOR  
HANGING BRACKET  
CONTOUR EDGEBAND REQUIRED

L = HEIGHT

W = DEPTH

EDGE IN FRONT OF UNIT

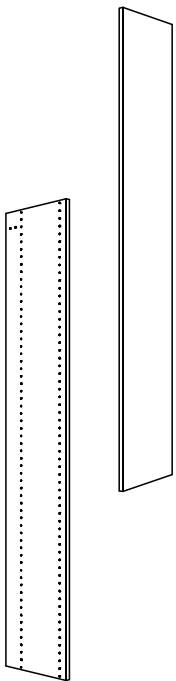

#### W14SB1L / W14RB1R

STOP DRILLED WALL HANGING  
DESIGNS FOR 14" DEPTH VERTICAL  
DRILLED 37mm FRONT FRONT  
261 FROM FRONT  
SQUARE BOTTOM  
DRILL FOR HANGING BRACKET

L = HEIGHT

W = DEPTH

EDGE IN FRONT OF UNIT

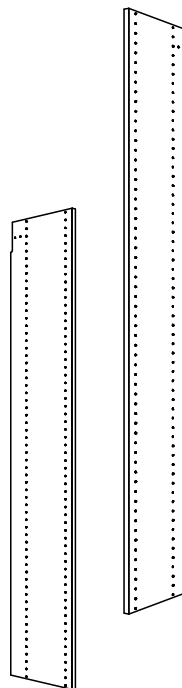

#### W14SB2

THRU DRILLED WALL HANGING  
DESIGNS FOR 14" DEPTH VERTICAL  
DRILLED 37mm FROM FRONT  
261 FROM FRONT  
SQUARE BOTTOM  
NOTCH AND DRILL FOR  
HANGING BRACKET

L = HEIGHT

W = DEPTH

EDGE IN FRONT OF UNIT

# PARTS CATALOG

## CLOSET VERTICAL PANELS

	<p><b>FS</b></p> <p>FIXED SHELF W/ 20mm HOLES TO ACCEPT CAMS DRILLED 37mm FRONT AND BACK</p> <p>L = INSIDE WIDTH W = DEPTH</p> <p>EDGE IN FRONT UNIT</p>		<p><b>AS</b></p> <p>ADJUSTABLE SHELF W/ NOTCH FOR PINS TO FIT 37 FRONT AND BACK</p> <p>L = INSIDE WIDTH W = DEPTH</p> <p>EDGE IN FRONT OF UNIT</p>
	<p><b>RCFS</b></p> <p>FIXED SHELF W/ 20mm HOLES TO ACCEPT CAMS DRILLED 37 FRONT 17 BACK</p> <p>L = INSIDE WIDTH W= DEPTH-20MM</p> <p>EDGE IN FRONT UNIT</p>		<p><b>RCAS</b></p> <p>ADJUSTABLE SHELF W/ NOTCH FOR PINS NOTCHED 37 FRONT 17 BACK</p> <p>L = INSIDE WIDTH W= DEPTH-20MM</p> <p>EDGE IN FRONT UNIT</p>
	<p><b>WFS</b></p> <p>FIXED SHELF W/ 20mm HOLES TO ACCEPT CAMS DRILLED 37/261 FROM FRONT TO FIT 14" WALL HANGING SYSTEM</p> <p>L = INSIDE WIDTH W = DEPTH</p> <p>EDGE IN FRONT OF UNIT</p>		<p><b>WAS</b></p> <p>ADJUSTABLE SHELF W/ 20mm HOLES TO ACCEPT CAMS NOTCHED 37/261 FROM FRONT TO FIT 14" WALL HANGING SYSTEM</p> <p>L = INSIDE WIDTH W = DEPTH</p> <p>EDGE IN FRONT OF UNIT</p>
	<p><b>B0</b></p> <p>BLANK SHELF NO MACHINING</p> <p>L = INSIDE WIDTH W = DEPTH</p> <p>EDGE IN FRONT OF UNIT</p>		



OPERATION 32

www.operation32.com

# EURO KITCHEN BOXES

Tel: 954-428-9797

Fax: 954-428-9191

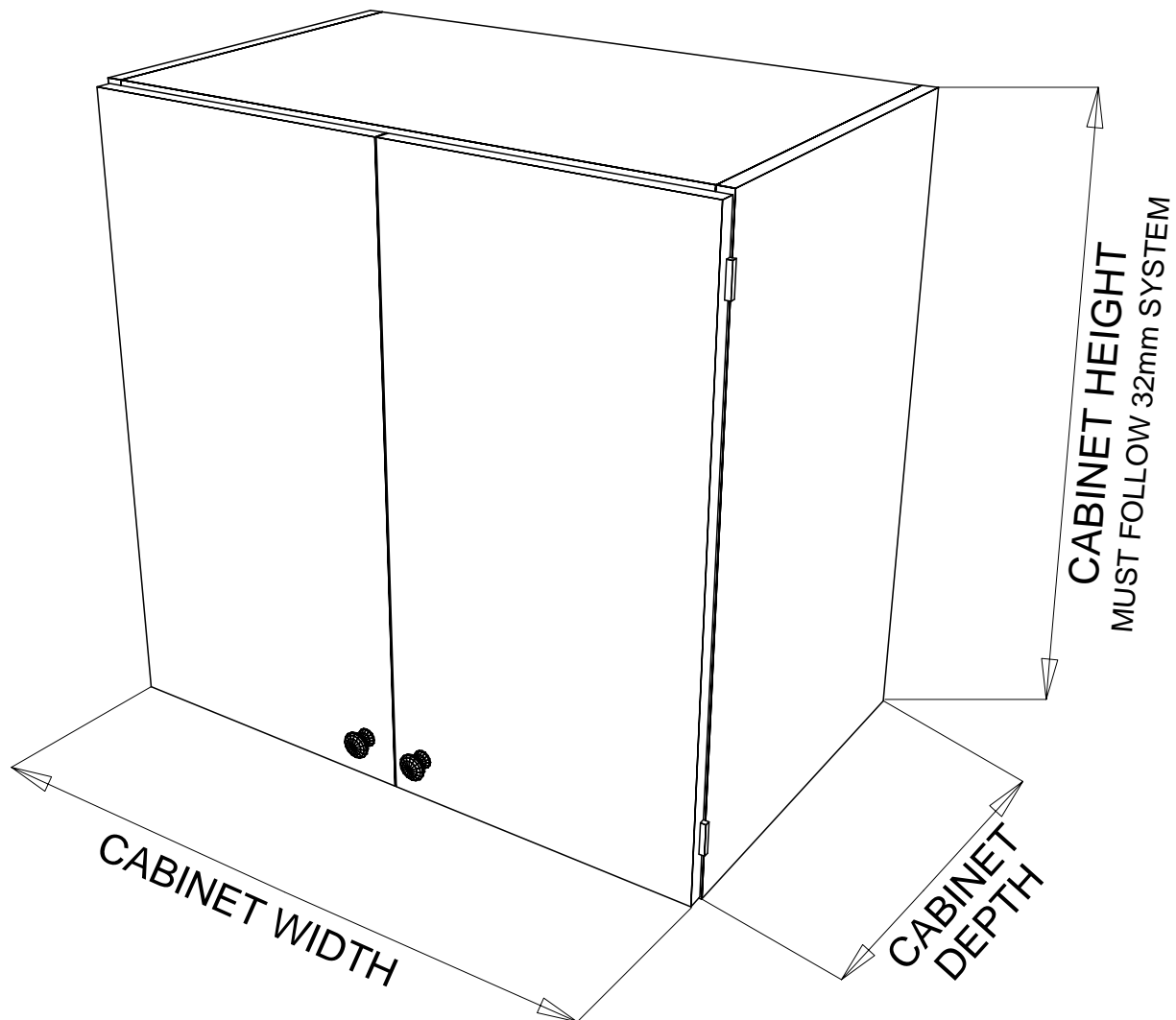

1" = 25.4mm

3/4" PANEL THICKNESS = 19mm

5051 N.W 13th Ave, Suite C, Deerfield Beach, FL 33064

GROOVE FOR 1/4" BACK  
3/4" FROM BACK

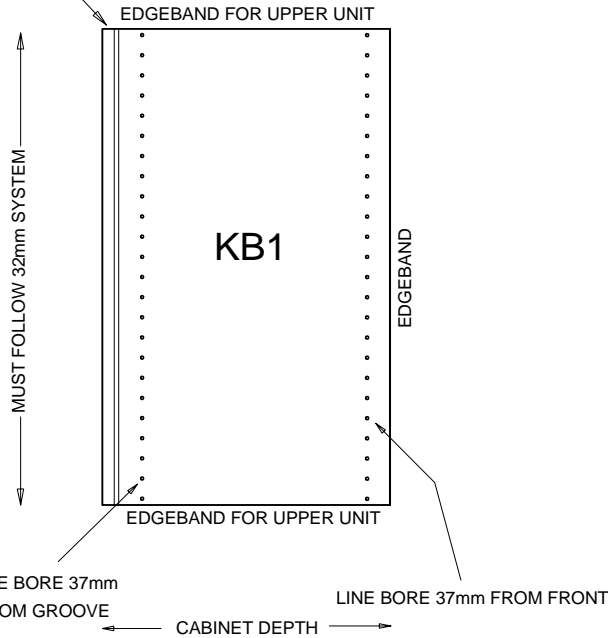

**NAILER**

CABINET WIDTH LESS 38mm

**STRETCHER**

EDGE BAND

**1/4" BACK**

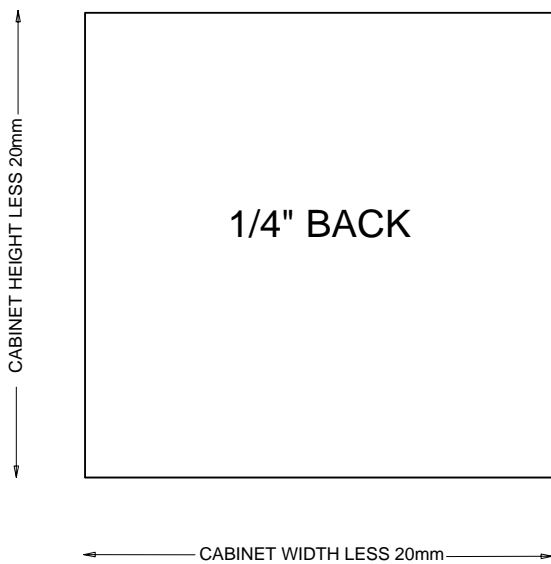

GROOVE FOR 1/4" BACK  
3/4" FROM BACK

EDGE BAND

**KB**

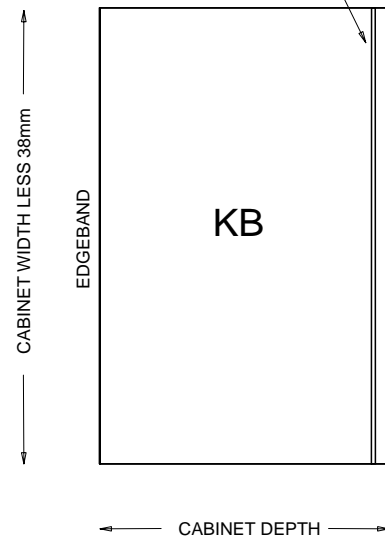

OPERATION 32

www.operation32.com

# EURO KITCHEN

kitchen Components

Tel: 954-428-9797

Fax: 954-428-9191

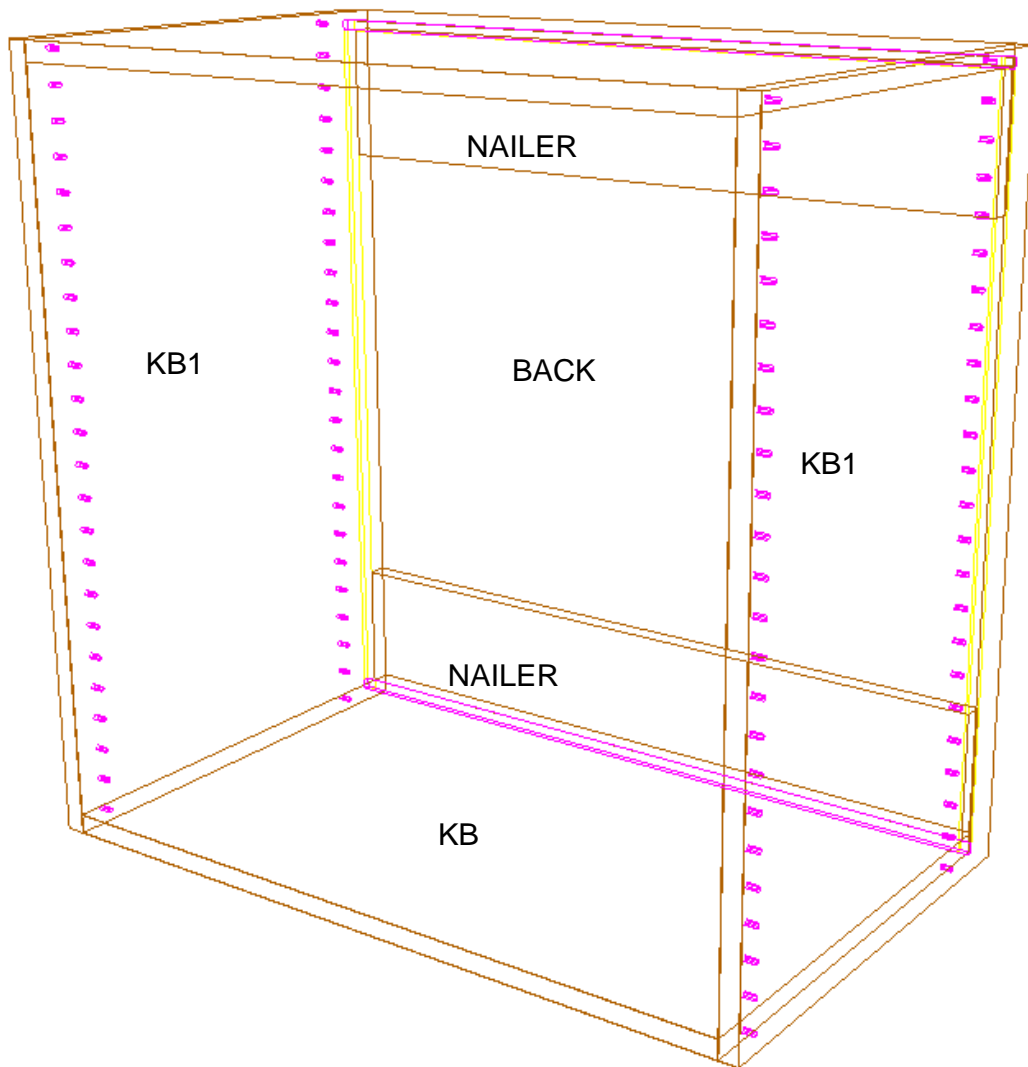

5051 N.W 13th Ave, Suite C, Deerfield Beach, FL 33064

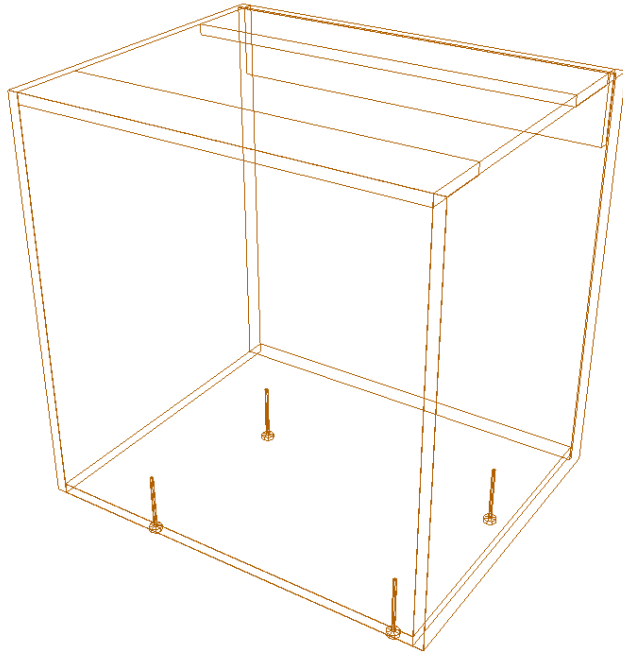

### PARTS FOR BASE CABINET

- 2 X KB1
- 1 X KB
- 1 X NAILER
- 2 X STRETCHER
- 1 X 1/4" BACK

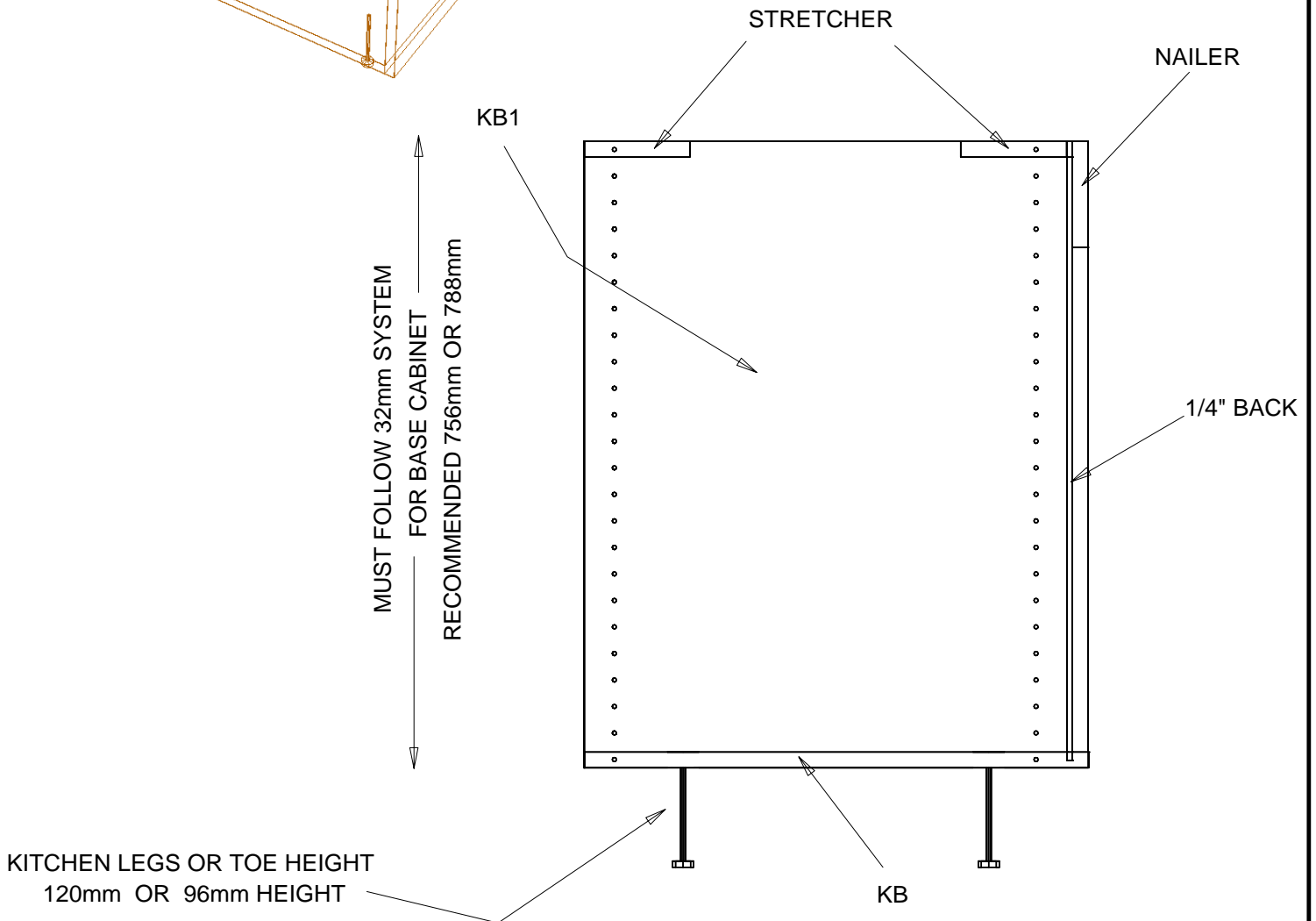

# EURO KITCHEN WALL CABINET

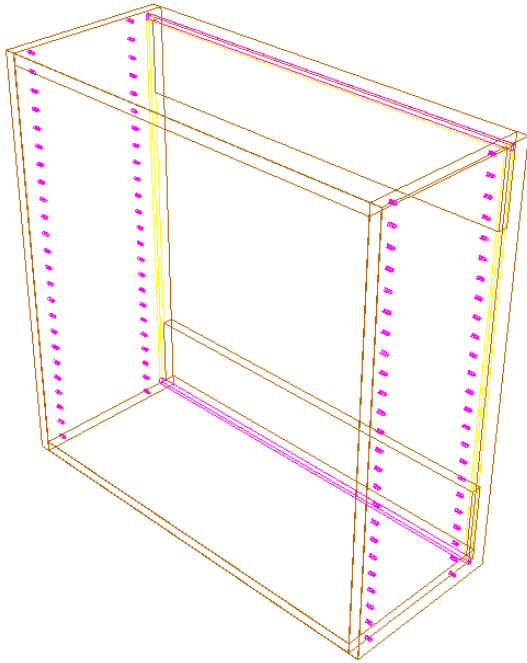

## PARTS FOR WALL CABINET

- 2 X KB1
- 2 X KB
- 2 X NAILER
- 1 X 1/4" BACK

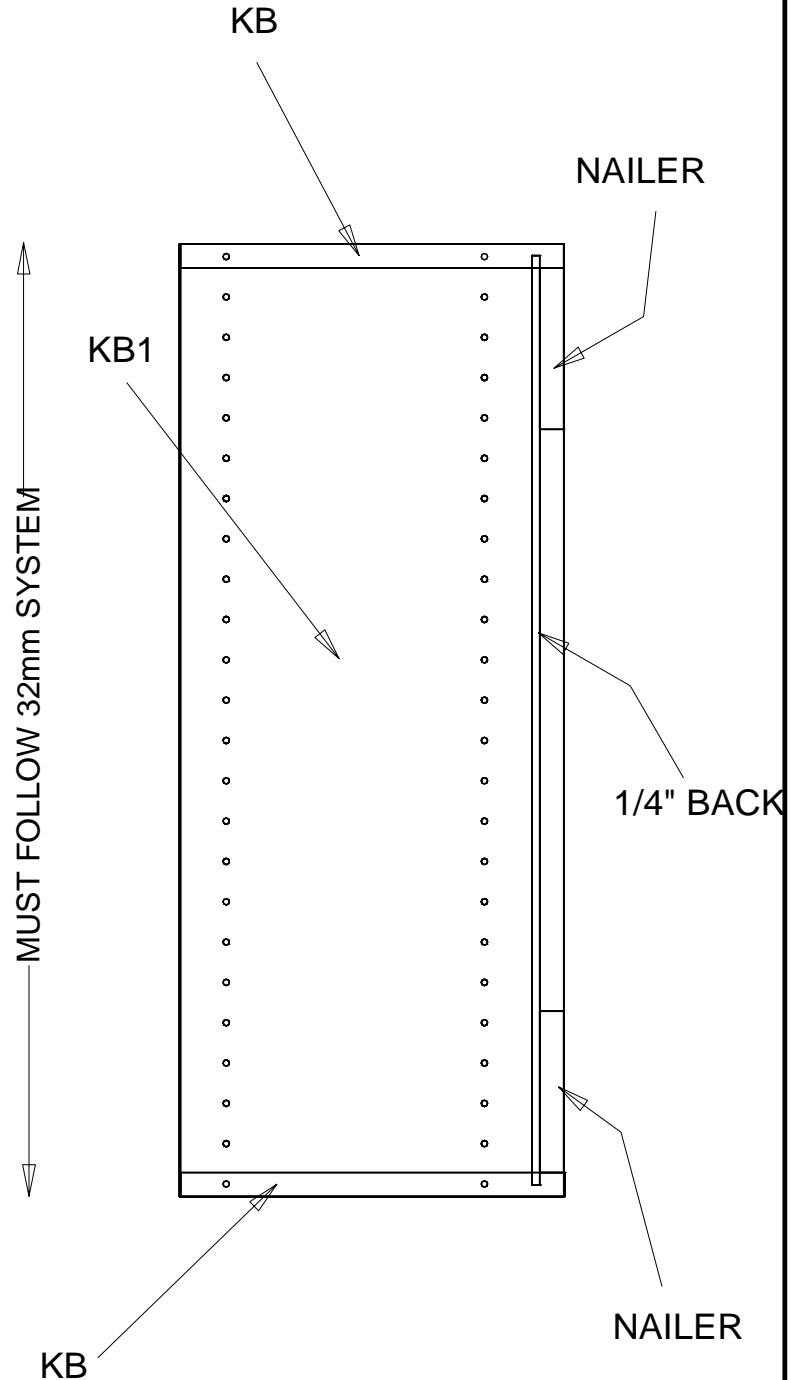

# EURO KITCHEN TALL CABINET

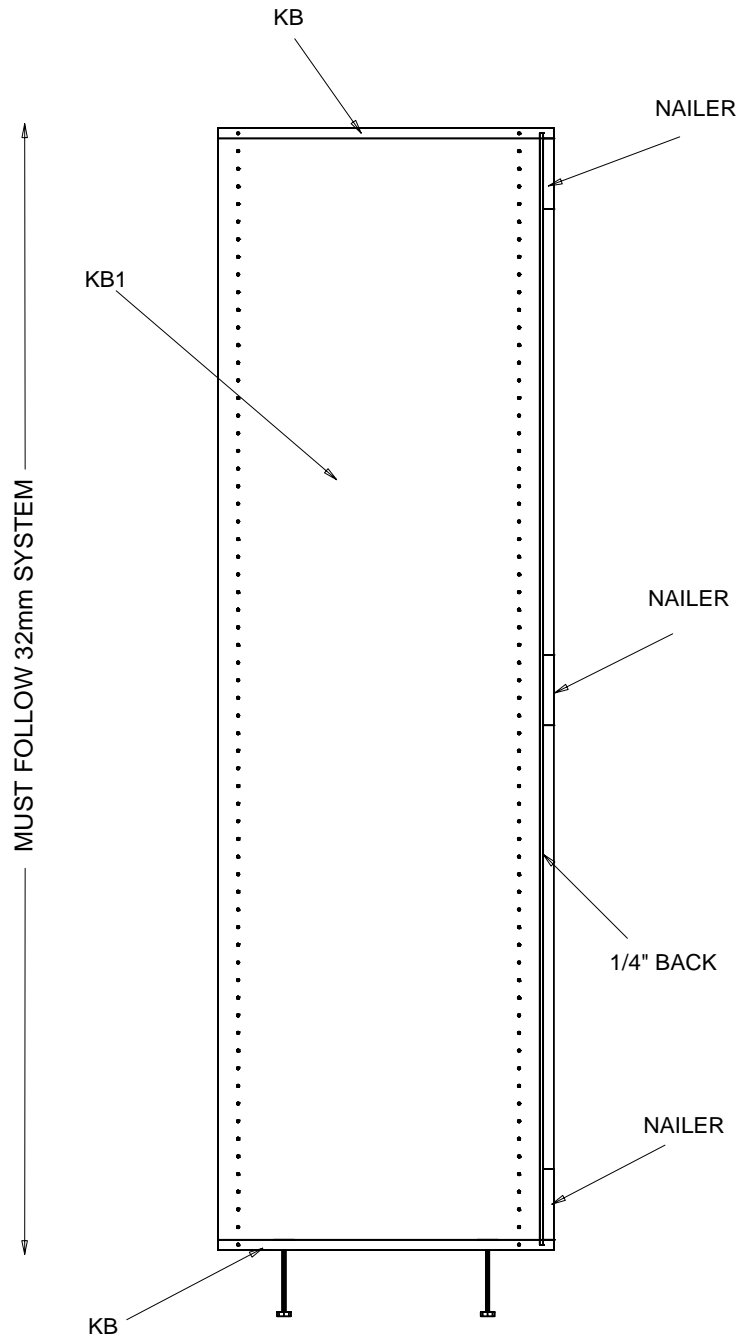
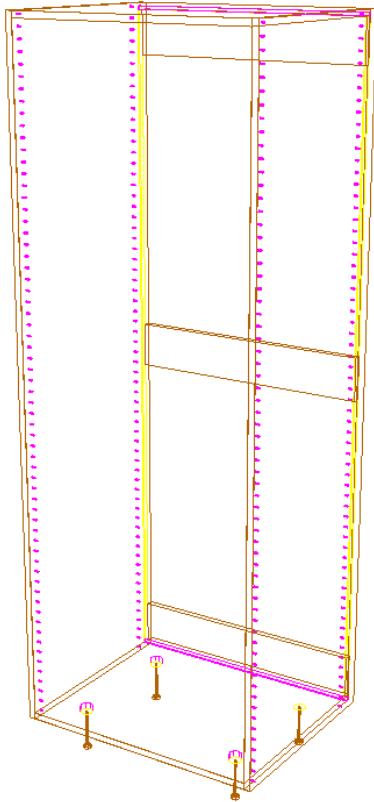

## PARTS FOR WALL CABINET

- 2 X KB1
- 2 X KB
- 3 X NAILER
- 1 X 1/4" BACK



www.operation32.com

# EURO KITCHEN SHELVES

Tel: 954-428-9797

Fax: 954-428-9191

## ADJUSTABLE SHELF

LENGTH = CABINET WIDTH LESS 42mm

WIDTH + CABINET DEPTH LESS 32mm

## FIXED SHELF

LENGTH = CABINET WIDTH LESS 38mm

WIDTH + CABINET DEPTH LESS 26mm

